

Table 13-1. IC201 (ST72E75)

pin #	MODES			pin #	MODES		
	31 kHz	68 kHz	96 kHz		31 kHz	68 kHz	96 kHz
1	0.25	0.25	0.25	22	4.00	3.70	3.77
2	0.25	0.25	0.25	23	GND	GND	GND
3	0.91	1.38	1.37	24	3.85	0.32	4.03
4	0.76	3.10	4.47	25	4.95	4.95	4.95
5	2.70	3.08	3.08	26	0	0	0
6	2.56	2.50	2.50	27	4.95	4.94	4.94
7	0.25	0.25	0.25	28	4.95	4.94	4.94
8	4.93	4.93	4.93	29	4.95	4.94	4.94
9	GND	GND	GND	30	4.95	4.93	4.93
10	4.96	4.94	4.94	31	0.06	0.06	0.06
11	4.95	4.94	4.94	32	2.28	2.28	2.28
12	4.95	4.95	4.95	33	2.21	2.21	2.21
13	NC	NC	NC	34	4.91	4.91	4.91
14	NC	NC	NC	35	4.92	4.92	4.92
15	4.35	0	0	36	12.01	0.06	0.06
16	0.11	0.12	0.17	37	12.01	0.06	0.06
17	0	0	0	38	9.65	9.66	0.06
18	4.99	4.98	4.84	39	12.01	0.06	0.06
19	4.95	4.95	4.95	40	4.96	4.96	4.96
20	0.02	0	0	41	GND	0	0
21	0.59	0.36	0.38	42	5.08	4.74	4.74

Unit: Vrms
 11: Right: 3.4 V, Left: 2.5 V, Down: 1.5 V, Up: 0.7 V
 12: S/W: 3.2 V, Menu: 2.4 V, Exit: 1.4 V

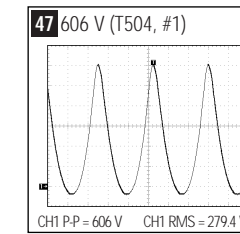
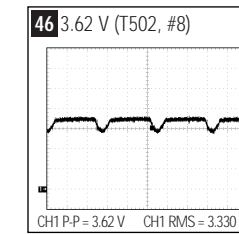
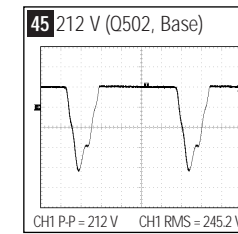
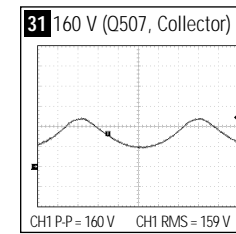
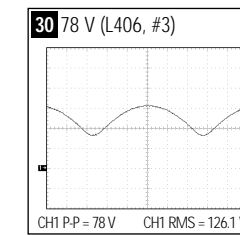
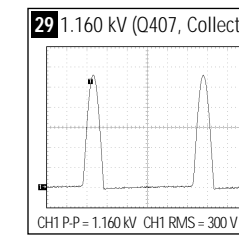
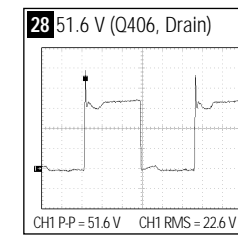
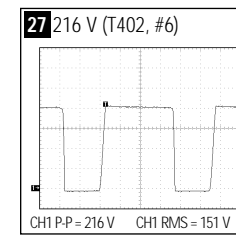
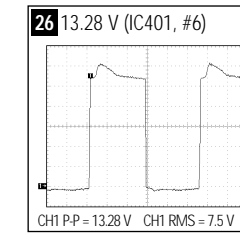
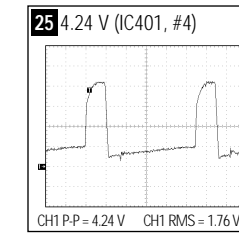
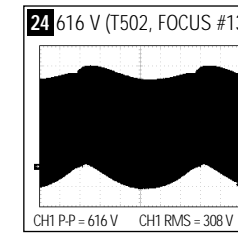
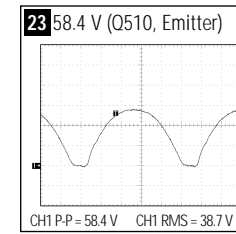
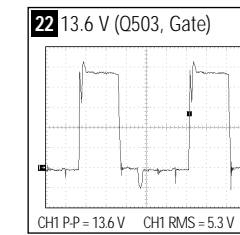
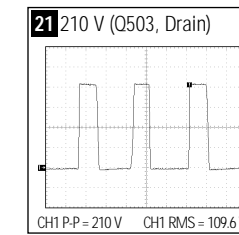
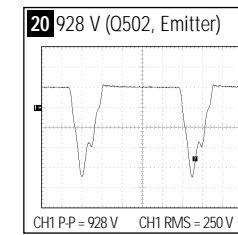
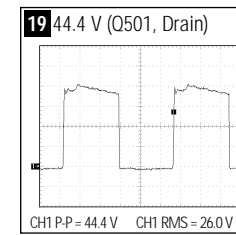

Table 13-2. IC403 (TDA9110)

pin #	MODES			pin #	MODES		
	31 kHz	68 kHz	96 kHz		31 kHz	68 kHz	96 kHz
1	0.59	0.36	0.38	17	GND	0	0
2	0.03	0.02	0.02	18	12.03	12.03	12.03
3	0.09	0.09	0.09	19	GND	0	0
4	3.28	3.26	3.26	20	5.38	5.16	5.12
5	3.20	2.51	2.16	21	8.04	8.04	8.04
6	6.33	6.32	6.32	22	3.50	3.50	3.50
7	3.97	3.95	3.94	23	3.55	3.52	3.51
8	1.52	3.34	4.72	24	3.10	3.11	3.11
9	1.52	3.34	4.72	25	0	0	0
10	3.41	3.16	3.16	26	5.79	5.68	5.60
11	GND	GND	GND	27	GND	0	0
12	-0.04	-0.12	-0.22	28	1.64	0.84	0.65
13	7.94	7.94	7.94	29	12.03	12.03	12.03
14	7.98	7.92	7.89	30	4.91	4.91	4.91
15	3.14	2.78	3.3	31	4.91	4.91	4.91
16	3.26	3.23	3.22	32	4.95	4.95	4.95

Unit: Vrms

13-3 Power Part Schematic Diagram

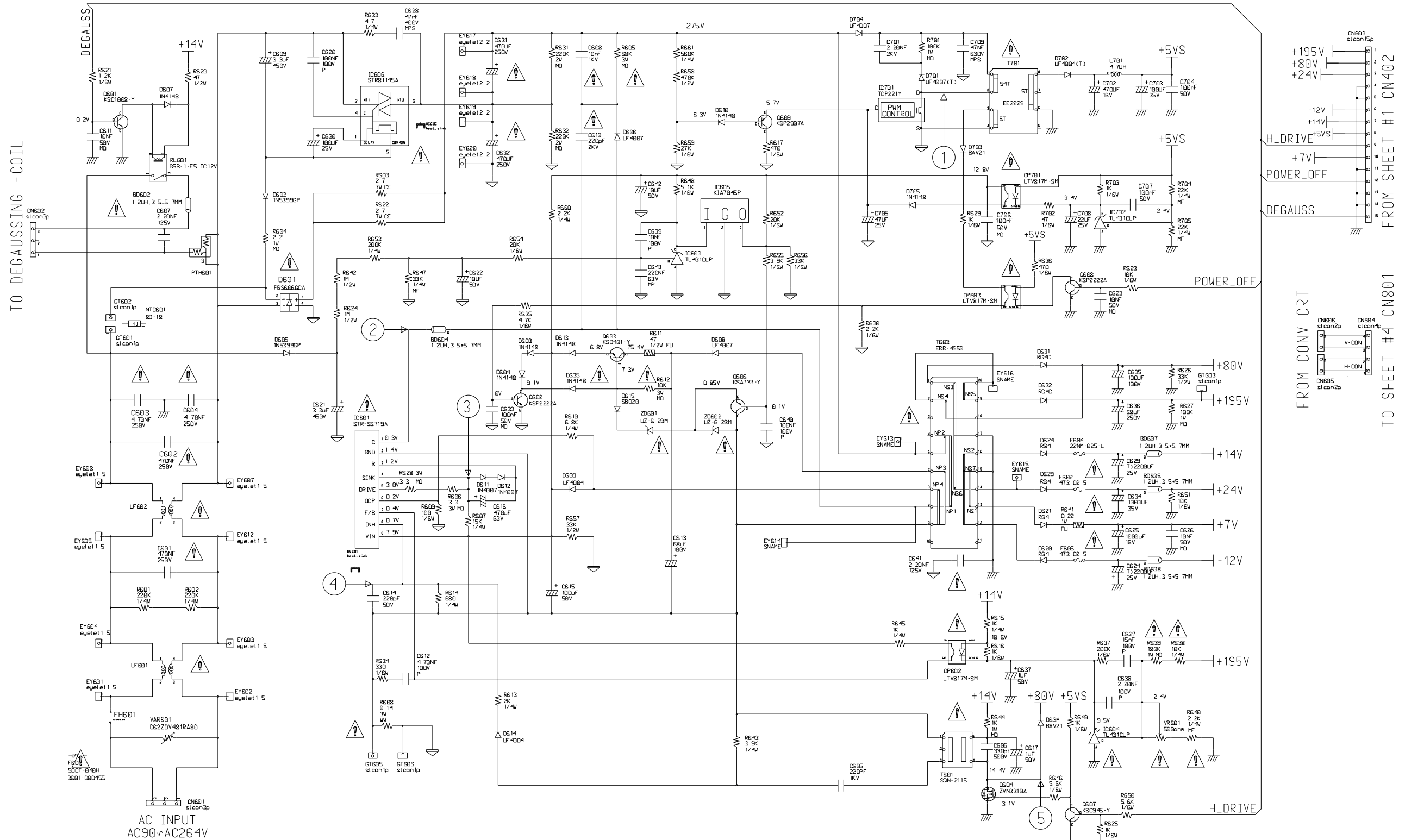

Table 13-3. IC401 (KA3843B)

pin #	MODES		
	31 kHz	68 kHz	93 kHz
1	3.78	3.03	2.81
2	2.49	2.49	2.49
3	0.87	0.51	0.32
4	1.59	1.42	1.49
5	GND	GND	GND
6	2.30	4.61	6.29
7	11.85	11.85	11.85
8	4.96	4.96	4.96

Unit: Vrms

Table 13-4. IC402 (TDA2006)

pin #	MODES		
	31 kHz	68 kHz	96 kHz
1	0.76	3.09	4.45
2	0.76	3.10	4.47
3	-12.04	-12.49	-12.49
4	-4.11	0.41	3.05
5	12.03	12.03	12.03

Unit: Vrms

Table 13-5. IC501 (TL494)

pin #	MODES		
	31 kHz	68 kHz	96 kHz
1	4.92	4.92	4.92
2	4.92	4.92	4.92
3	1.48	1.35	1.31
4	0	0	0
5	0.01	0.63	0.61
6	3.51	3.51	3.51
7	GND	GND	GND
8	12.00	12.00	12.00
9	3.19	4.03	4.67
10	3.19	4.03	4.67
11	12.00	12.00	12.00
12	12.00	12.00	12.00
13	GND	GND	GND
14	4.92	4.92	4.92
15	7.03	7.15	7.20
16	4.92	4.92	4.92

Unit: Vrms

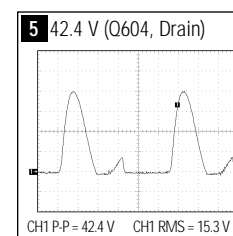
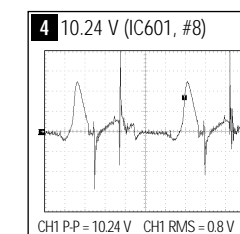
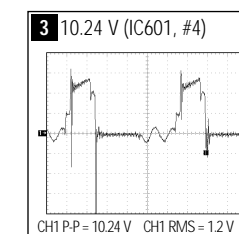
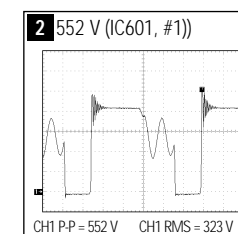
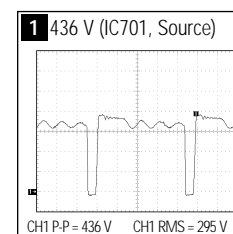

13-4 Video & CRT & Convergence & Key Part Schematic Diagram

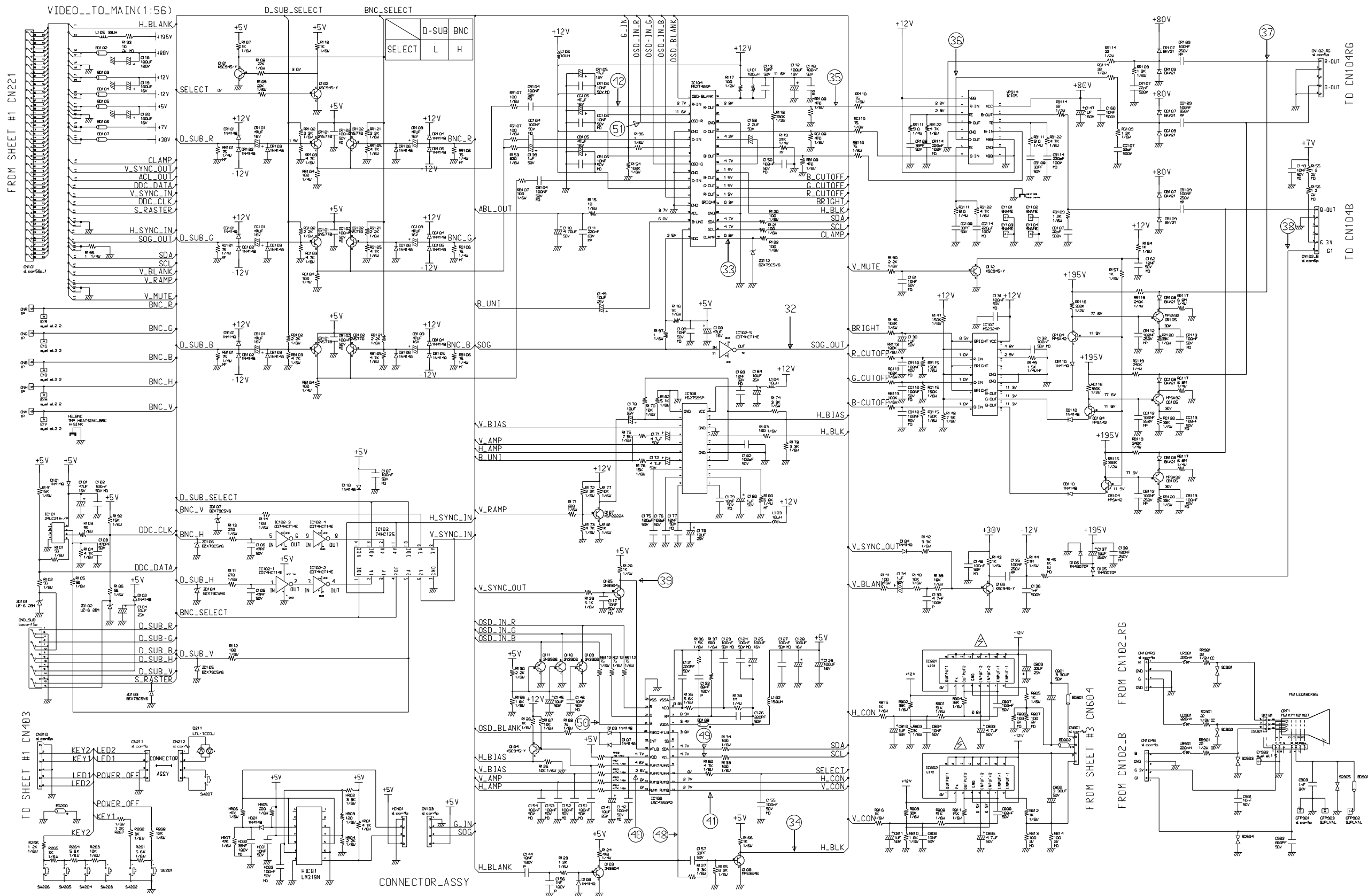

Table 13-6. IC301 (TDA8172)

pin #	MODES		
	31 kHz	68 kHz	96 kHz
1	1.19	1.19	1.19
2	14.85	14.91	14.91
3	-11.67	-11.73	-11.67
4	-12.10	-12.32	-12.33
5	0.01	0.12	0.07
6	14.45	14.63	14.68
7	1.19	1.19	1.19

Unit: Vrms

Table 13-7. IC106 (LSC4350P2)

pin #	MODES			pin #	MODES		
	31 kHz	68 kHz	96 kHz		31 kHz	68 kHz	96 kHz
1	0.24	0.34	0.45	13	0	0	0
2	0.55	0.71	1.00	14	0	0	0
3	0.55	0.71	1.00	15	2.12	2.09	2.07
4	4.90	4.89	4.88	16	4.25	4.17	4.08
5	4.13	3.82	3.59	17	4.89	4.85	4.83
6	NC	NC	NC	18	4.90	4.89	4.89
7	4.91	4.91	4.91	19	NC	NC	NC
8	4.91	4.91	4.91	20	0.42	0.42	0
9	NC	NC	NC	21	0	0	0
10	0	0	0	22	0	0	0
11	2.31	2.30	2.29	23	0	0	0
12	2.31	2.29	2.28	24	GND	0	0

Unit: Vrms

Table 13-8. IC107 (M52324P)

pin #	MODES		
	31 kHz	68 kHz	96 kHz
1	0.42	0.42	0.42
2	0.56	0.56	0.56
3	0.97	0.97	0.97
4	0.42	0.42	0.42
5	0.56	0.56	0.56
6	0.96	0.96	0.96
7	0.42	0.42	0.42
8	0.56	0.56	0.56
9	0.76	0.76	0.76
10	11.38	11.38	11.38
11	11.38	11.38	11.38
12	11.39	11.39	11.39
13	GND	0	0
14	GND	0	0
15	NC	NC	NC
16	2.96	2.96	2.96
17	4.89	4.89	4.89
18	11.97	11.97	11.97

Unit: Vrms

Table 13-9. IC108 (M52759SP)

pin #	MODES		
	31 kHz	68 kHz	96 kHz
1	0	0	0
2	2.36	2.36	2.36
3	2.14	2.14	2.13
4	4.96	4.96	4.96
5	0.01	0.01	0.01
6	0.01	0.01	0.01
7	7.58	7.58	7.58
8	6.03	6.02	6.02
9	6.02	6.00	5.93
10	11.67	11.67	11.67
11	2.71	2.80	2.82
12	3.87	3.98	4.06
13	1.23	1.23	1.23
14	6.93	6.93	6.93
15	0	0	0
16	0.05	0.06	0.07
17	0.40	0.71	0.94
18	0	0	0
19	6.11	6.07	6.03
20	11.69	11.69	11.69

Unit: Vrms

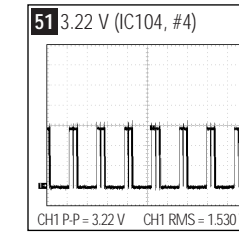
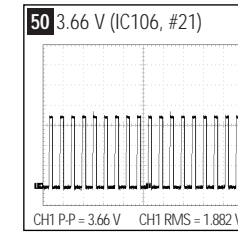
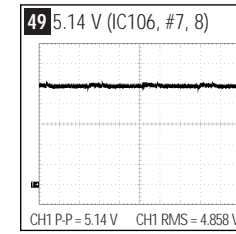
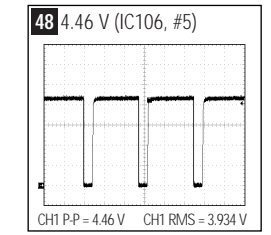
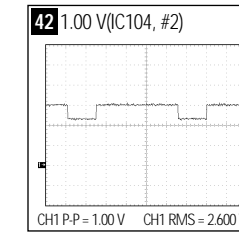
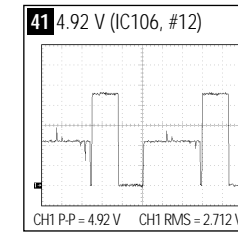
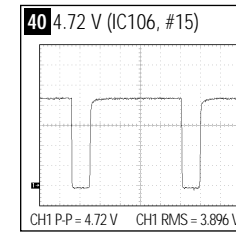
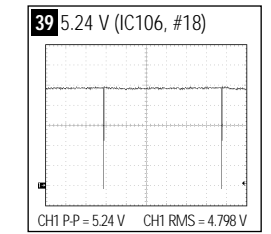
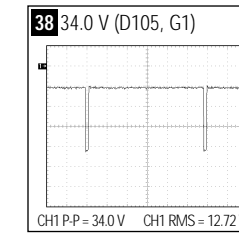
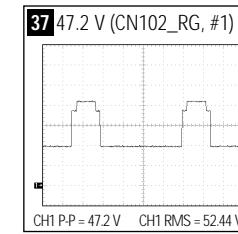
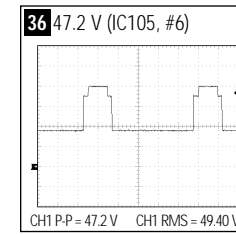
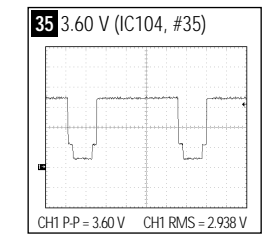
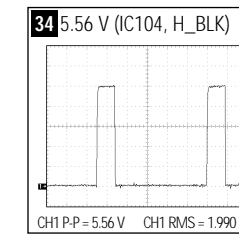
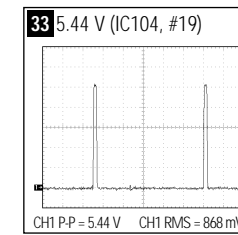
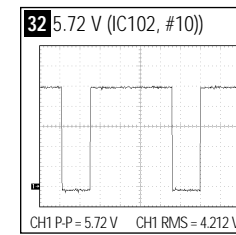

Memo